



EXPANDED GRAPHITE GASKET SHEETS

TEMAGRAPH S



A comprehensive range of graphite products to cover every application

Temac, a.s. manufacture and distributor of a range of graphite sheets designed for demanded fluid sealing applications. The products are manufactured from high purity expanded graphite and are available in a variety of configurations.

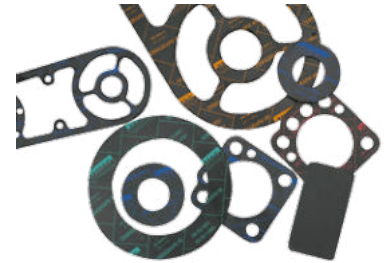

TEMAGRAPH FI



Graphite sheets are typically used for sealing at higher temperature than can be recommended with CSF (Compressed Synthetic Fibre) materials. When the graphite is reinforced with a metallic insert, they are also capable of sealing against high pressures.

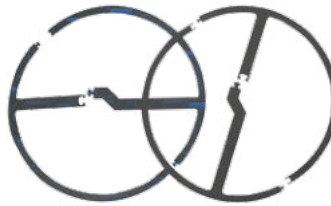
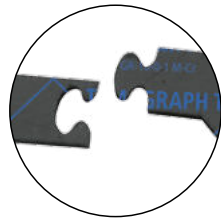

Due to the compressible nature of the expanded graphite, large or unusually shaped gaskets can be fabricated from dovetailed segments. The segments interlock and join together under compressive load.

TEMAGRAPH TI



For applications requiring very high levels of tightness, inner and outer metallic eyelets can be fitted to both standard and non-standard shaped gaskets.

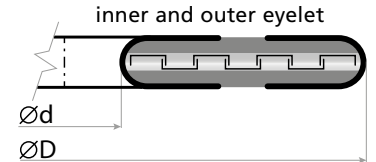
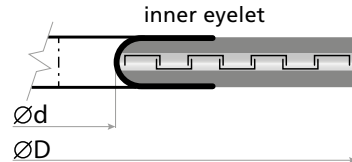

TEMAGRAPH NI

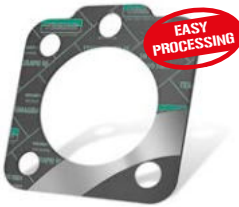

Graphite gaskets can be cut using water jet technology, allowing complex and diverse shapes to be fabricated with minimum waste.

CNC cutting technology is also available for both single and multiple components, producing high levels of accuracy at rapid speed.

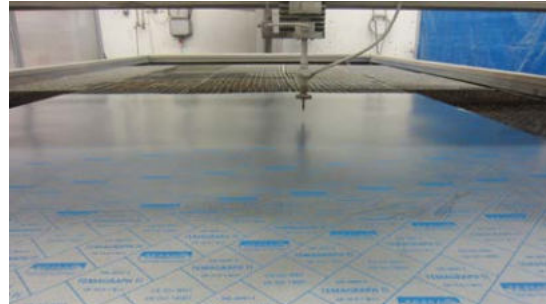

TEMAGRAPH HP



TEMAGRAPH TG

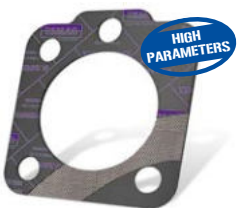

APPLICATION OF TEMAC GRAPHITE GASKETS

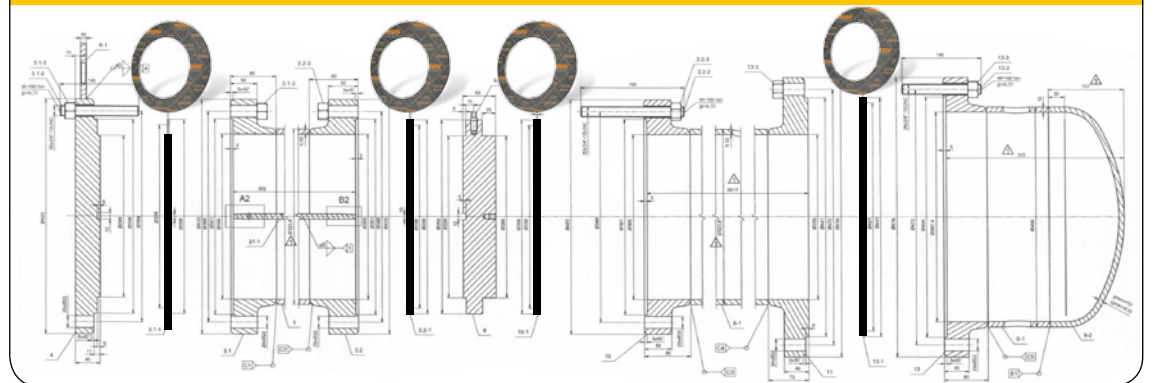

TEMAGRAPH S



TEMAGRAPH FI



PRINTING COLOUR

DESCRIPTION AND APPLICATION

WITHOUT BRANDING

Temagraph S is a basic sheet made of expanded graphite without reinforcement. This product is also used in the manufacturing of Temagraph materials with stainless steel or nickel foil insertions.

RED BRANDING

Temagraph FI is a graphite laminate product reinforced with one or more thin flat metallic insertions which are bonded using a chloride-free adhesive layer. It is general service material for high pressure and high temperature applications including steam. This material is mainly used in chemical, petrochemical and related industries.

Marking acc. to	DIN 28 091-4	GR-10	GR-10-O-1 K-Cr
Sheet size	m	1,0 x 1,0 (1,5 x 1,5)	1,0 x 1,0 (1,5 x 1,5)
Thickness	mm	from 1,0 to 3,0	from 0,75 to 3,0
No. of insertion	pc	without insertion	1 or 2
Thickness of insertions	mm	–	0,05
Material of insertion	DIN / ASTM	–	1.4401 / SS 316 (flat)
Max. temperature*	°C	from - 200 to +500	from - 200 to +500
Max. pressure*	bar	60	100
Density	g/cm ³	0,7–1,3	0,7–1,0
Compressibility ASTM F 36A	%	40–50	40–50
Recovery ASTM F 36A	%	10–15	10–15
Residual stress DIN 52 913, 300°C/50MPa	N/mm ²	> 47	≥ 45
Tensile strenght	MPa	> 4	unlisted
Ash content DIN 51 903	%	≤ 2,0	≤ 2,0
Chloride content	ppm	≤ 50	≤ 50

* max. values can not be used simultaneously
 – gasket factors on requested
 – if required the material can be supplied in so-called nuclear grade

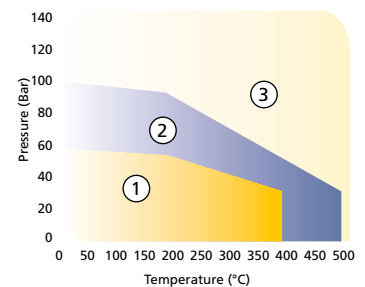
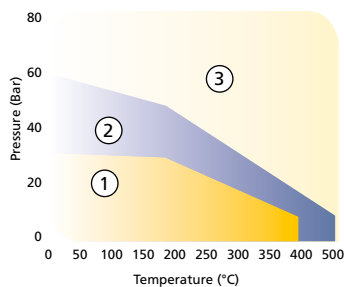

Legend: 1 - suitable subject to chemical compactability
 2 - suitable extended area, technical advice is recommended
 3 - for this area technical consultation is mandatory

TEMAGRAPH TI



BLUE BRANDING

Temagraph TI is a graphite laminate product reinforced with one or more tanged metallic insertions. It is designed to be used in demanding applications, providing reliable long term service. Temagraph TI is largely used in flange connections for piping, vessels and other machinery. It is suitable for steam systems and process duties in the chemical, petrochemical, power and manufacturing industries.

TEMAGRAPH NI



GREEN BRANDING

Temagraph NI is made of high purity, exfoliated graphite reinforced with a flat nickel insertion. It is designed for general applications within the chemical and petrochemical and manufacturing industries. The sheets are easy to handle and cut.

TEMAGRAPH HP



ORANGE BRANDING

Temagraph HP is high integrity, multilayer sheet material with outstanding mechanical strength. It is designed for higher pressure and temperature applications and for flange connections where resistance to high bolt loadings is required. Temagraph HP is manufactured from the high purity expanded graphite foil reinforced with a number of perforated steel inserts (thickness 0,05mm) without the use of adhesive. This sandwich design confers high compressive strength to the material making it suitable for tongue and groove and exchanger applications as well as variety of demanding applications in the oil, refining and chemical industries. The multilayer composition also ensures that the product adapts well to a variety of flange surfaces.

TEMAGRAPH TG

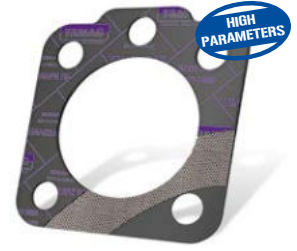

VIOLET BRANDING

Temagraph TG is high quality, graphite sealing sheet reinforced with an expanded, three-dimensional, stainless steel insert. The unique geometry of the expanded metal insert combined with the excellent sealing properties of the expanded graphite foils, provide the sheet with excellent thermal and mechanical loading capabilities. Temagraph TG is especially suitable for petrochemical, oil, chemical and heating plant industry applications.

GR-10-O-1 M-Cr
1,0 x 1,0 (1,5 x 1,5)
from 1,0 to 3,0
1 or 2
0,1
1.4401 / SS 316 (tanged)
from -200 to +500
140
1,0
30-40
15-20
> 48
unlisted
≤ 2,0
≤ 50

GR-10-I-1 K-Ni
1,0 x 1,0 (1,5 x 1,5)
from 0,8 to 3,0
1 or 2
0,013
2.4066 / nickel foil (flat)
from -200 to +500
100
0,7-1,0
40-50
10-15
≥ 45
unlisted
≤ 2,0
≤ 50

GR-11-I-3 M-Cr
1,0 x 1,0 (1,5 x 1,5)
from 1,0 to 4,0
1 to 7
0,05
1.4401 / SS 316 (tanged)
from -200 to +550
200
1,1
30-40
4-5
>48
unlisted
< 1,0
< 25

GR-13-O-1MK- Cr
1,0 x 1,0 (1,5 x 1,5)
from 1,0 to 3,0
1
0,15 (Passo 6 mm)
1.4404 / SS 316L (expanded)
from -200 to +550
200
1,35
40
15
37 according to BS
unlisted
≤ 2,0
≤ 50

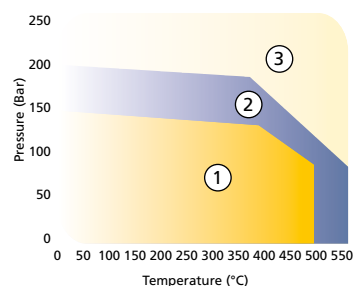
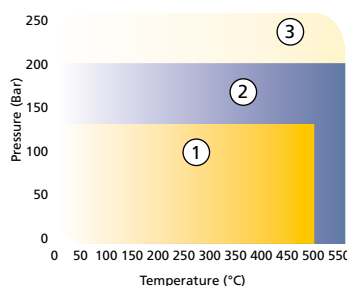
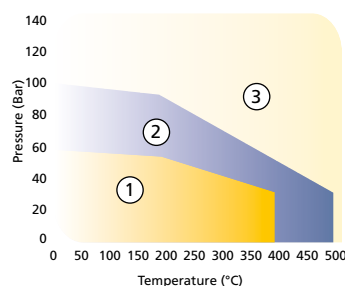
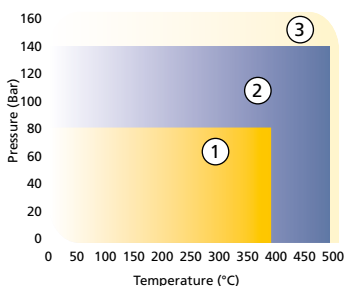

CHEMICAL RESISTANCE TABLE

	TEMAGRAPH						
	S	FI	TI	NI	HP	TG	
Chloroform	A	A	A	A	A	A	A
Chromic acid (up to 20%)	B	C	C	C	C	C	C
Iso-octane	A	A	A	A	A	A	A
Isopropyl alcohol	A	A	A	A	A	A	A
Kerosene	A	A	A	A	A	A	A
Methylene chloride	A	A	A	A	A	A	A
Nitric acid 20%	C	C	C	C	C	C	C
Nitric acid (over 85%)	B	B	B	B	B	B	B
Nitric acid (up to 65%)	A	A	A	A	A	A	A
Nitrobenzene	A	A	A	A	A	A	A
Nitrogen	A	A	A	A	A	A	A
Oil crude naphta	A	A	A	A	A	A	A
Oil heating	A	A	A	A	A	A	A
Oil hydraulic mineral	A	A	A	A	A	A	A
Oil motor	A	A	A	A	A	A	A
Oil silicon	A	A	A	A	A	A	A
Oil transformer	A	A	A	A	A	A	A
Oxalic acid	A	B	B	B	B	B	B
Oxygen (up to 350° C)	A	A	A	A	A	A	A
Paraffin	A	A	A	A	A	A	A
Petrol	A	A	A	A	A	A	A
Phenol	A	A	A	A	A	A	A
Phosphoric acid 95%	A	A	A	A	A	A	A
Potassium cyanide	A	A	A	A	A	A	A
Potassium dichromate	A	B	B	B	B	B	B
Potassium chloride	A	A	A	A	A	A	A
Potassium iodide	A	A	A	A	A	A	A
Potassium nitrate	A	B	B	B	B	B	B
Soap solutions	A	A	A	A	A	A	A
Sodium carbonate	A	A	A	A	A	A	A
Sodium hydrogen carbonate	A	A	A	A	A	A	A
Sodium hydroxide	A	B	B	B	B	B	B
Sodium chloride	A	B	B	B	B	B	B
Sodium sulphate	A	A	A	A	A	A	A
Steam saturated	A	A	A	A	A	A	A
Sugar	A	A	A	A	A	A	A
Sulphuric acid 30%	A	B	B	B	B	B	B
Sulphuric acid 70%	A	C	C	C	C	C	C
Sulphurous acid	A	B	B	B	B	B	B
Tartaric acid	A	A	A	A	A	A	A
Tetrachlorethane	A	A	A	A	A	A	A
Tetrachloromethane	A	A	A	A	A	A	A
Toluene	A	A	A	A	A	A	A
Turpentine	A	A	A	A	A	A	A
Vinyl chloride	A	A	A	A	A	A	A
Water	A	A	A	A	A	A	A
Water chlorinated	A	A	A	A	A	A	A
Water potable	A	A	A	A	A	A	A
Water sea	A	A	A	A	A	A	A
Water waste	A	A	A	A	A	A	A
Xylene	A	A	A	A	A	A	A

A- suitable for application

B - suitable depends on conditions

C - not suitable

If another medium is applied please contact our technical team.

	TEMAGRAPH						
	S	FI	TI	NI	HP	TG	
Acetic acid 10%	A	A	A	A	A	A	A
Acetone	A	A	A	A	A	A	A
Acetylene	A	A	A	A	A	A	A
Adipic acid	A	A	A	A	A	A	A
Air	A	A	A	A	A	A	A
Alum	A	A	A	A	A	A	A
Aluminium chloride	A	C	C	C	C	C	C
Ammonia	A	A	A	A	A	A	A
Ammonium hydrogenphosphate	A	A	A	A	A	A	A
Ammonium hydroxide	A	A	A	A	A	A	A
Ammonium chloride	A	B	B	B	B	B	B
Aniline	A	A	A	A	A	A	A
Aqua regia	C	C	C	C	C	C	C
Asphalt	A	A	A	A	A	A	A
Barium chloride	A	A	A	A	A	A	A
Benzene	A	A	A	A	A	A	A
Boric acid	A	A	A	A	A	A	A
Butane	A	A	A	A	A	A	A
Butyl alcohol	A	A	A	A	A	A	A
Calcium hydroxide	A	A	A	A	A	A	A
Calcium hypochloride	A	B	B	B	B	B	B
Calcium sulphate	A	A	A	A	A	A	A
Carbon dioxide	A	A	A	A	A	A	A
Carbon disulphide	A	A	A	A	A	A	A
Cooper sulphate	A	A	A	A	A	A	A
Cyclohexanone	A	A	A	A	A	A	A
Di-butyl phthalate	A	A	A	A	A	A	A
Ethane	A	A	A	A	A	A	A
Ethyl acetate	A	A	A	A	A	A	A
Ethyl alcohol	A	A	A	A	A	A	A
Ethyl ether	A	A	A	A	A	A	A
Ethyl chloride	A	A	A	A	A	A	A
Ethylene	A	A	A	A	A	A	A
Ethylene glycol	A	A	A	A	A	A	A
Fluorine dioxide	C	C	C	C	C	C	C
Fluorine gas	B	C	C	C	C	C	C
Fluorine liquid	C	C	C	C	C	C	C
Formaldehyde	A	A	A	A	A	A	A
Fuel aviation	A	A	A	A	A	A	A
Gas LPG	A	A	A	A	A	A	A
Gas natural	A	A	A	A	A	A	A
Glycerine	A	A	A	A	A	A	A
Hydrofluoric acid (up to 40%)	B	C	C	C	C	C	C
Hydrogen	A	A	A	A	A	A	A
Hydrogen fluoride	A	C	C	C	C	C	C
Hydrogen chloride	A	A	A	A	A	A	A
Hydrogen chloride dry	A	A	A	A	A	A	A
Hydrogen chloride wet	A	C	C	C	C	C	C
Hydrogen peroxide 6%	A	A	A	A	A	A	A
Hydrochloric acid 20%	B	C	C	C	C	C	C
Chlorine dry	A	A	A	A	A	A	A
Chlorine water	C	C	C	C	C	C	C
Chlorine wet	C	C	C	C	C	C	C
Chlormethane	A	A	A	A	A	A	A

Contact:Temac, a.s.
289 13 Zvěřinek
Czech Republic**Sales:**Tel.:
+420 325 550 246
+420 325 550 109
+420 325 550 243**Fax:**+420 325 551 402
+420 325 550 250
+420 325 550 284**E-mail:**export@temac.cz
eastsales@temac.cz
sngsales@temac.cz**Web:**

www.temac.cz, info@temac.cz

Tech. dept.:Tel.:
+420 325 550 181**Fax:**

+420 325 550 284

E-mail:

tech.help@temac.cz